

EXTENSION TUBE

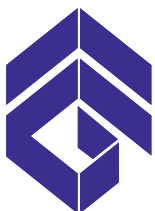

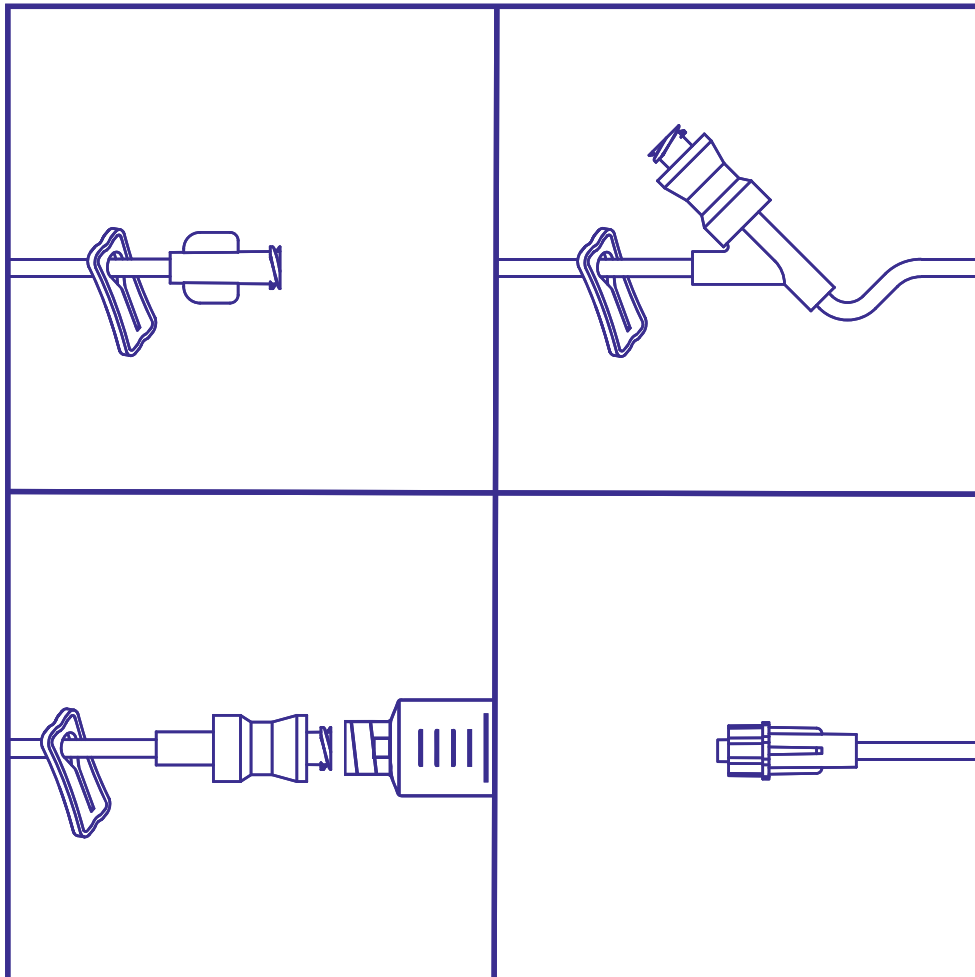

EXTENSION TUBE

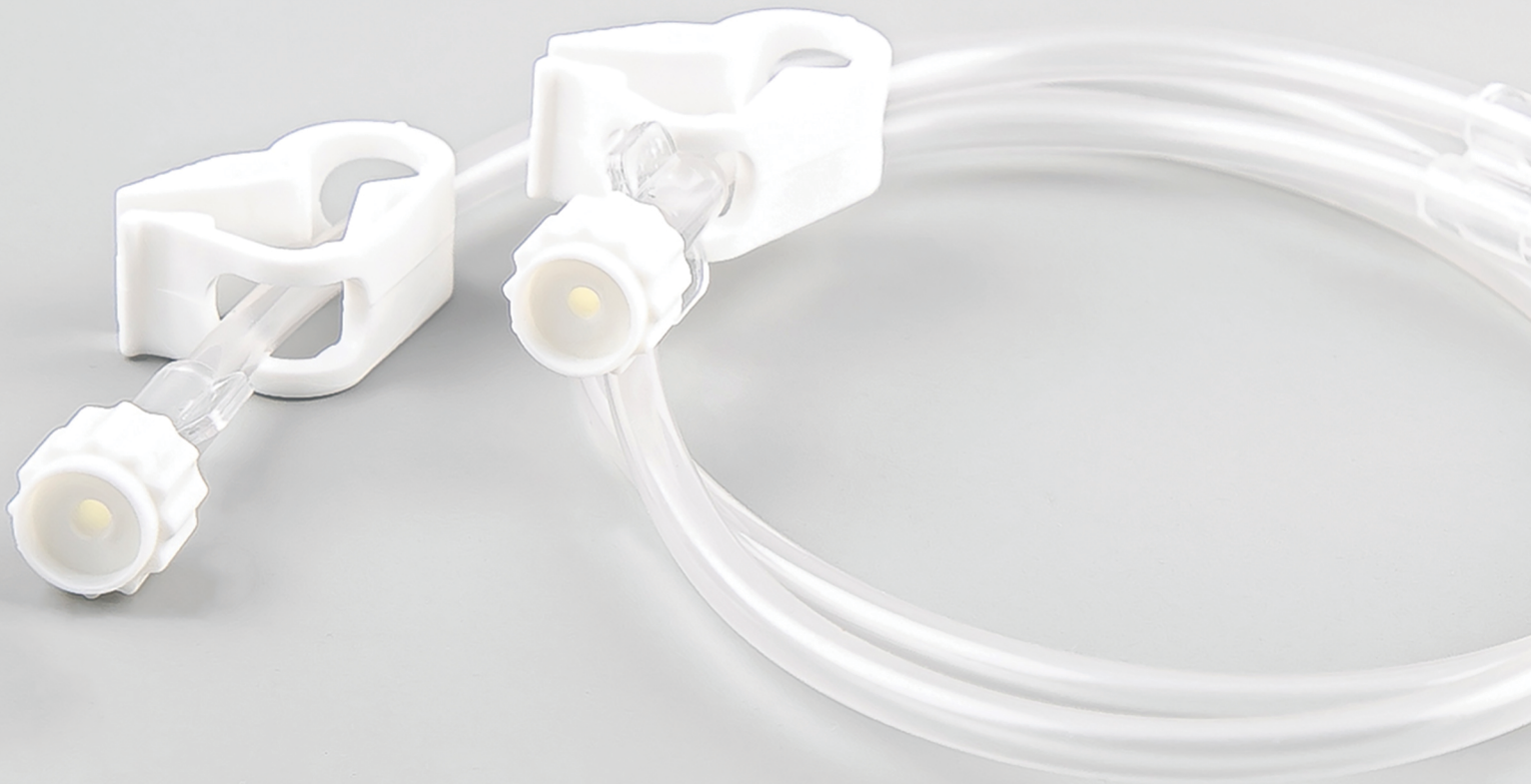

**Asia
Goldman co.**
Medical Equipment

LUER LOCK EXTENSION TUBES FAMILY

One way luer lock extension tube, Model: ES1A



| Length (cm) | OD x ID (mm) | | | Priming volume (ml) | | | Reference Code | | |
|----------------|-----------------|-------|---------|------------------------|------|------|----------------|--------|--------|
| | 4.1x3 | 3.2x2 | 2.5x1.3 | | | | | | |
| 15 | 4.1x3 | 3.2x2 | 2.5x1.3 | 1.12 | 0.64 | 0.43 | ES1A1 | ES1A8 | ES1A15 |
| 30 | 4.1x3 | 3.2x2 | 2.5x1.3 | 2.18 | 1.12 | 0.62 | ES1A2 | ES1A9 | ES1A16 |
| 60 | 4.1x3 | 3.2x2 | 2.5x1.3 | 4.3 | 2.06 | 1.02 | ES1A3 | ES1A10 | ES1A17 |
| 80 | 4.1x3 | 3.2x2 | 2.5x1.3 | 5.71 | 2.69 | 1.29 | ES1A4 | ES1A11 | ES1A18 |
| 110 | 4.1x3 | 3.2x2 | 2.5x1.3 | 7.83 | 3.63 | 1.69 | ES1A5 | ES1A12 | ES1A19 |
| 150 | 4.1x3 | 3.2x2 | 2.5x1.3 | 10.66 | 4.88 | 2.22 | ES1A6 | ES1A13 | ES1A20 |
| 200 | 4.1x3 | 3.2x2 | 2.5x1.3 | 14.19 | 6.45 | 2.88 | ES1A7 | ES1A14 | ES1A21 |

Each row along with the color represents OD x ID ,P.V and model.

Two way luer lock extension tube, Model: ES2A

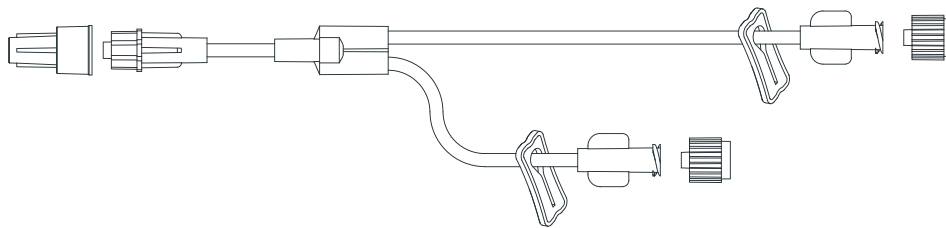

| Length (cm) | OD x ID (mm) | | | Priming volume (ml) | | | Reference Code | | |
|----------------|-----------------|-------|---------|------------------------|------|------|----------------|--------|--------|
| | 4.1x3 | 3.2x2 | 2.5x1.3 | | | | | | |
| 30 | 4.1x3 | 3.2x2 | 2.5x1.3 | 3.13 | 1.70 | 1.05 | ES2A1 | ES2A7 | ES2A13 |
| 60 | 4.1x3 | 3.2x2 | 2.5x1.3 | 5.25 | 2.65 | 1.44 | ES2A2 | ES2A8 | ES2A14 |
| 80 | 4.1x3 | 3.2x2 | 2.5x1.3 | 6.66 | 3.27 | 1.71 | ES2A3 | ES2A9 | ES2A15 |
| 110 | 4.1x3 | 3.2x2 | 2.5x1.3 | 8.78 | 4.22 | 2.11 | ES2A4 | ES2A10 | ES2A16 |
| 150 | 4.1x3 | 3.2x2 | 2.5x1.3 | 11.61 | 5.47 | 2.64 | ES2A5 | ES2A11 | ES2A17 |
| 200 | 4.1x3 | 3.2x2 | 2.5x1.3 | 15.14 | 7.04 | 3.30 | ES2A6 | ES2A12 | ES2A18 |

Each row along with the color represents OD x ID ,P.V and model.

Two way luer lock extension tube, Model: ES2B

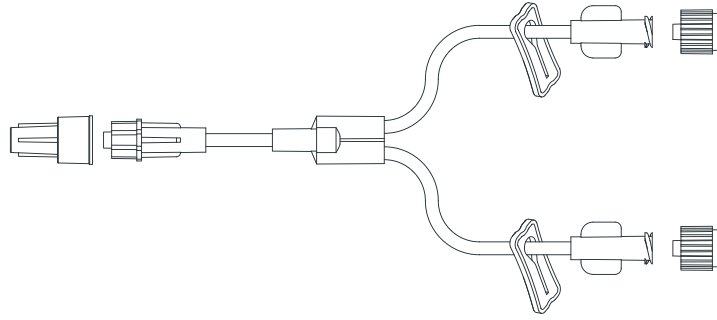

| Length (cm) | OD x ID (mm) | | | Priming volume (ml) | | | Reference Code | | |
|-------------|--------------|-------|---------|---------------------|------|------|----------------|-------|-------|
| 15 | 4.1x3 | 3.2x2 | 2.5x1.3 | 1.86 | 1.14 | 0.81 | ES2B1 | ES2B3 | ES2B5 |
| 20 | 4.1x3 | 3.2x2 | 2.5x1.3 | 2.56 | 1.45 | 0.94 | ES2B2 | ES2B4 | ES2B6 |

Each row along with the color represents OD x ID ,P.V and model.

Three way luer lock extension tube, Model: ES3A

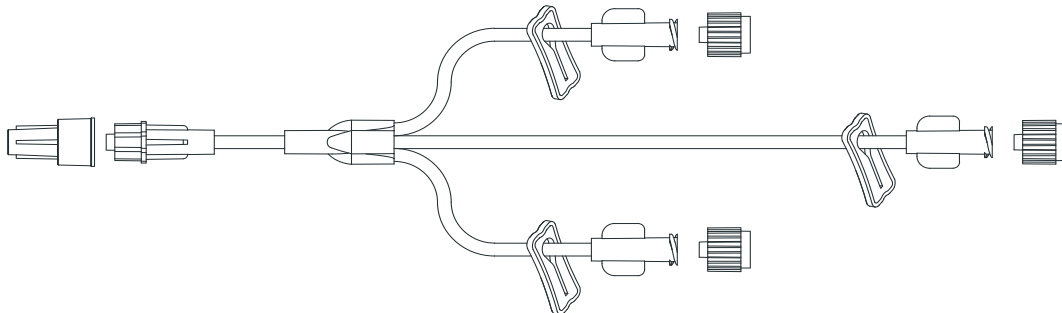

| Length (cm) | OD x ID (mm) | | | Priming volume (ml) | | | Reference Code | | |
|-------------|--------------|-------|---------|---------------------|------|------|----------------|--------|--------|
| 30 | 4.1x3 | 3.2x2 | 2.5x1.3 | 3.92 | 2.09 | 1.35 | ES3A1 | ES3A7 | ES3A13 |
| 60 | 4.1x3 | 3.2x2 | 2.5x1.3 | 6.03 | 3.03 | 1.75 | ES3A2 | ES3A8 | ES3A14 |
| 80 | 4.1x3 | 3.2x2 | 2.5x1.3 | 7.44 | 3.66 | 2.02 | ES3A3 | ES3A9 | ES3A15 |
| 110 | 4.1x3 | 3.2x2 | 2.5x1.3 | 9.56 | 4.6 | 2.42 | ES3A4 | ES3A10 | ES3A16 |
| 150 | 4.1x3 | 3.2x2 | 2.5x1.3 | 12.15 | 5.85 | 2.94 | ES3A5 | ES3A11 | ES3A17 |
| 200 | 4.1x3 | 3.2x2 | 2.5x1.3 | 15.69 | 7.42 | 3.61 | ES3A6 | ES3A12 | ES3A18 |

Each row along with the color represents OD x ID ,P.V and model.

Three way luer lock extension tube, Model: ES3B

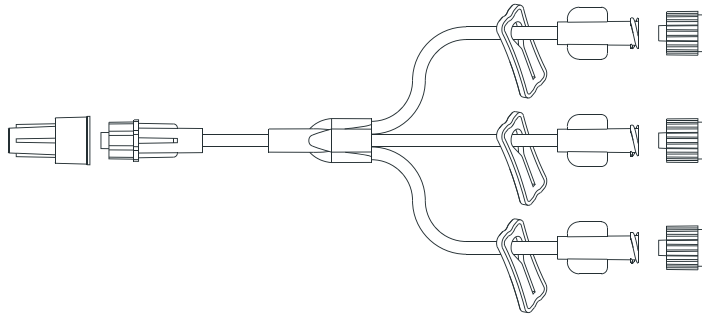

| Length (cm) | OD x ID (mm) | | | Priming volume (ml) | | | Reference Code | | |
|----------------|-----------------|-------|---------|------------------------|------|------|----------------|-------|-------|
| | 4.1x3 | 3.2x2 | 2.5x1.3 | 2.62 | 1.62 | 1.15 | ES3B1 | ES3B3 | ES3B5 |
| 15 | 4.1x3 | 3.2x2 | 2.5x1.3 | 2.62 | 1.62 | 1.15 | ES3B1 | ES3B3 | ES3B5 |
| 20 | 4.1x3 | 3.2x2 | 2.5x1.3 | 3.67 | 1.86 | 1.35 | ES3B2 | ES3B4 | ES3B6 |

Each row along with the color represents OD x ID ,P.V and model.

Four way luer lock extension tube, Model: ES4A

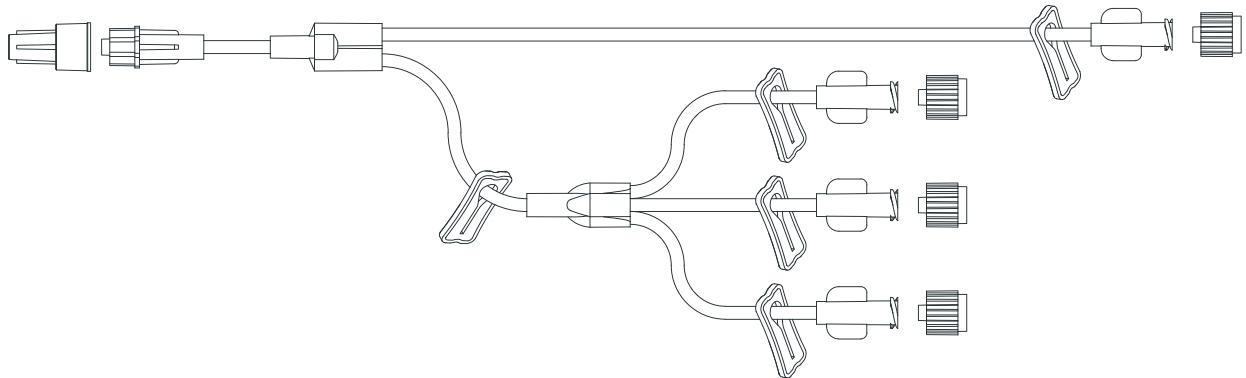

| Length (cm) | OD x ID (mm) | | | Priming volume (ml) | | | Reference Code | | |
|----------------|-----------------|-------|---------|------------------------|------|------|----------------|--------|--------|
| | 4.1x3 | 3.2x2 | 2.5x1.3 | 5.45 | 3.04 | 1.93 | ES4A1 | ES4A7 | ES4A13 |
| 30 | 4.1x3 | 3.2x2 | 2.5x1.3 | 5.45 | 3.04 | 1.93 | ES4A1 | ES4A7 | ES4A13 |
| 60 | 4.1x3 | 3.2x2 | 2.5x1.3 | 7.57 | 3.98 | 2.33 | ES4A2 | ES4A8 | ES4A14 |
| 80 | 4.1x3 | 3.2x2 | 2.5x1.3 | 8.98 | 4.61 | 2.59 | ES4A3 | ES4A9 | ES4A15 |
| 110 | 4.1x3 | 3.2x2 | 2.5x1.3 | 11.1 | 5.55 | 2.99 | ES4A4 | ES4A10 | ES4A16 |
| 150 | 4.1x3 | 3.2x2 | 2.5x1.3 | 13.92 | 6.81 | 3.52 | ES4A5 | ES4A11 | ES4A17 |
| 200 | 4.1x3 | 3.2x2 | 2.5x1.3 | 17.46 | 8.38 | 4.18 | ES4A6 | ES4A12 | ES4A18 |

Each row along with the color represents OD x ID ,P.V and model.

Four way luer lock extension tube, Model: ES4B

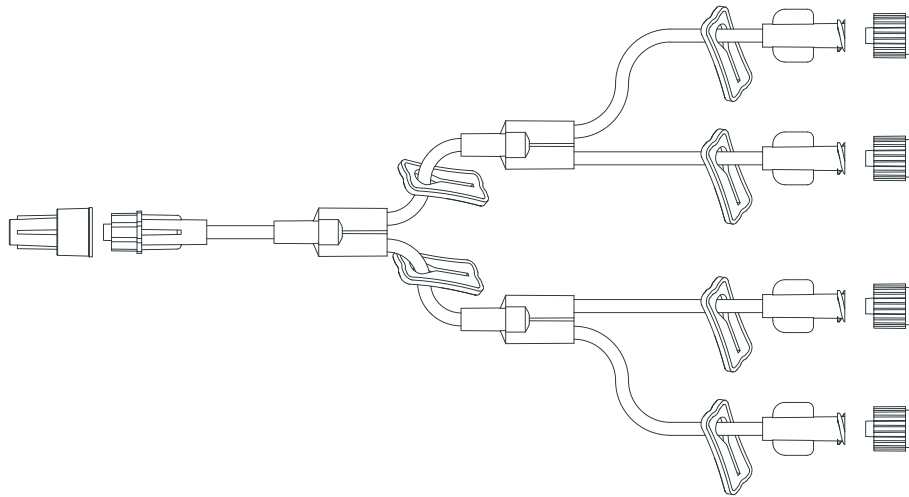

| Length (cm) | OD x ID (mm) | | | Priming volume (ml) | | | Reference Code | | |
|----------------|-----------------|-------|---------|------------------------|------|------|----------------|-------|-------|
| 20 | 4.1x3 | 3.2x2 | 2.5x1.3 | 3.93 | 2.39 | 1.68 | ES4B1 | ES4B2 | ES4B3 |

Each row along with the color represents OD x ID ,P.V and model.

Five way luer lock extension tube, Model: ES5A

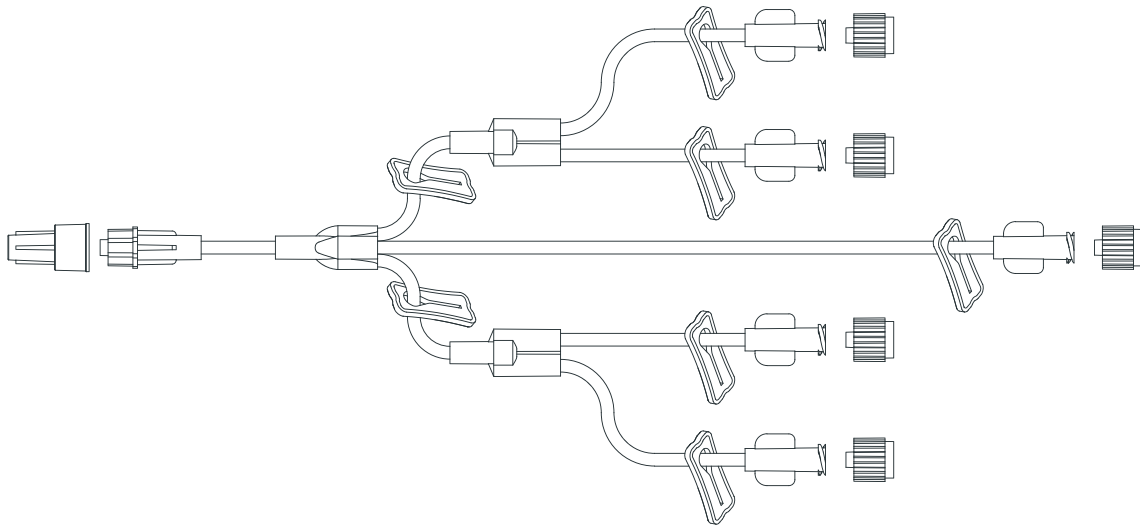

| Length (cm) | OD x ID (mm) | | | Priming volume (ml) | | | Reference Code | | |
|----------------|-----------------|-------|---------|------------------------|------|------|----------------|--------|--------|
| 30 | 4.1x3 | 3.2x2 | 2.5x1.3 | 5.27 | 3.13 | 2.14 | ES5A1 | ES5A7 | ES5A13 |
| 60 | 4.1x3 | 3.2x2 | 2.5x1.3 | 7.38 | 4.07 | 2.54 | ES5A2 | ES5A8 | ES5A14 |
| 80 | 4.1x3 | 3.2x2 | 2.5x1.3 | 8.80 | 4.7 | 2.8 | ES5A3 | ES5A9 | ES5A15 |
| 110 | 4.1x3 | 3.2x2 | 2.5x1.3 | 10.92 | 5.64 | 3.2 | ES5A4 | ES5A10 | ES5A16 |
| 150 | 4.1x3 | 3.2x2 | 2.5x1.3 | 13.74 | 6.89 | 3.73 | ES5A5 | ES5A11 | ES5A17 |
| 200 | 4.1x3 | 3.2x2 | 2.5x1.3 | 17.28 | 8.46 | 4.39 | ES5A6 | ES5A12 | ES5A18 |

Each row along with the color represents OD x ID ,P.V and model.

NEEDLE FREE EXTENSION TUBE FAMILY

One way needle free extension tube, Model: EV1A



| Length (cm) | OD x ID (mm) | | | Priming volume (ml) | | | Reference Code | | |
|-------------|--------------|-------|---------|---------------------|------|------|----------------|--------|--------|
| 15 | 4.1x3 | 3.2x2 | 2.5x1.3 | 0.89 | 0.48 | 0.29 | EV1A1 | EV1A8 | EV1A15 |
| 30 | 4.1x3 | 3.2x2 | 2.5x1.3 | 1.95 | 0.95 | 0.49 | EV1A2 | EV1A9 | EV1A16 |
| 60 | 4.1x3 | 3.2x2 | 2.5x1.3 | 4.07 | 1.89 | 0.89 | EV1A3 | EV1A10 | EV1A17 |
| 80 | 4.1x3 | 3.2x2 | 2.5x1.3 | 5.48 | 2.52 | 1.16 | EV1A4 | EV1A11 | EV1A18 |
| 110 | 4.1x3 | 3.2x2 | 2.5x1.3 | 7.6 | 3.46 | 1.55 | EV1A5 | EV1A12 | EV1A19 |
| 150 | 4.1x3 | 3.2x2 | 2.5x1.3 | 10.43 | 4.72 | 2.08 | EV1A6 | EV1A13 | EV1A20 |
| 200 | 4.1x3 | 3.2x2 | 2.5x1.3 | 13.96 | 6.29 | 2.75 | EV1A7 | EV1A14 | EV1A21 |

Each row along with the color represents OD x ID ,P.V and model.

Two way needle free extension tube, Model: EV2A

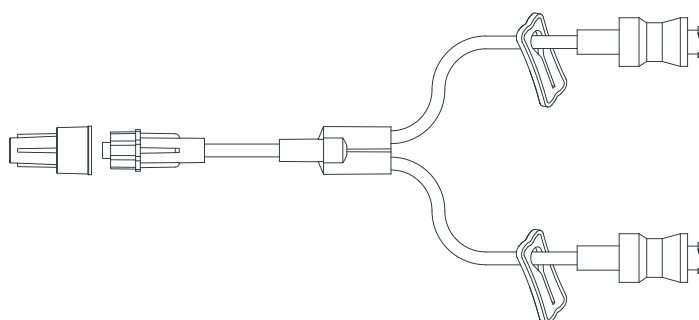

| Length (cm) | OD x ID (mm) | | | Priming volume (ml) | | | Reference Code | | |
|-------------|--------------|-------|---------|---------------------|------|------|----------------|-------|-------|
| 15 | 4.1x3 | 3.2x2 | 2.5x1.3 | 1.4 | 0.81 | 0.54 | EV2A1 | EV2A2 | EV2A3 |

Each row along with the color represents OD x ID ,P.V and model.

Two way needle free extension tube (Continued), Model: EV2B

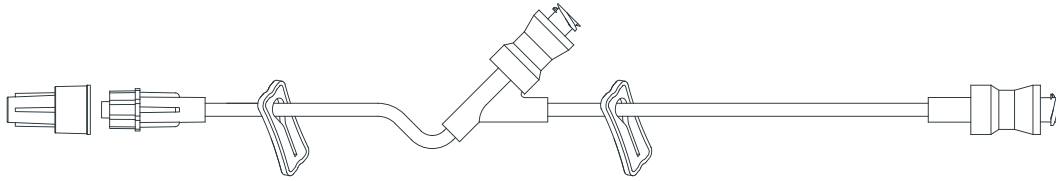

| Length (cm) | OD x ID (mm) | | | Priming volume (ml) | | | Reference Code | | |
|----------------|-----------------|-------|---------|------------------------|------|------|----------------|-------|-------|
| | 4.1x3 | 3.2x2 | 2.5x1.3 | 5.83 | 2.95 | 1.61 | EV2B1 | EV2B4 | EV2B7 |
| 80 | 4.1x3 | 3.2x2 | 2.5x1.3 | 5.83 | 2.95 | 1.61 | EV2B1 | EV2B4 | EV2B7 |
| 150 | 4.1x3 | 3.2x2 | 2.5x1.3 | 10.8 | 5.15 | 2.54 | EV2B2 | EV2B5 | EV2B8 |
| 220 | 4.1x3 | 3.2x2 | 2.5x1.3 | 15.74 | 7.34 | 3.46 | EV2B3 | EV2B6 | EV2B9 |

Each row along with the color represents OD x ID ,P.V and model.

Three way needle free extension tube, Model: EV3A

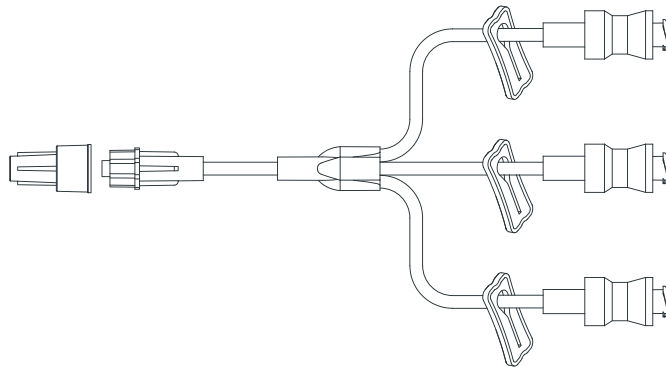

| Length (cm) | OD x ID (mm) | | | Priming volume (ml) | | | Reference Code | | |
|----------------|-----------------|-------|---------|------------------------|------|------|----------------|-------|-------|
| | 4.1x3 | 3.2x2 | 2.5x1.3 | 1.91 | 1.12 | 0.75 | EV3A1 | EV3A2 | EV3A3 |
| 15 | 4.1x3 | 3.2x2 | 2.5x1.3 | 1.91 | 1.12 | 0.75 | EV3A1 | EV3A2 | EV3A3 |

Each row along with the color represents OD x ID ,P.V and model.

Three way needle free extension tube, Model: EV3B

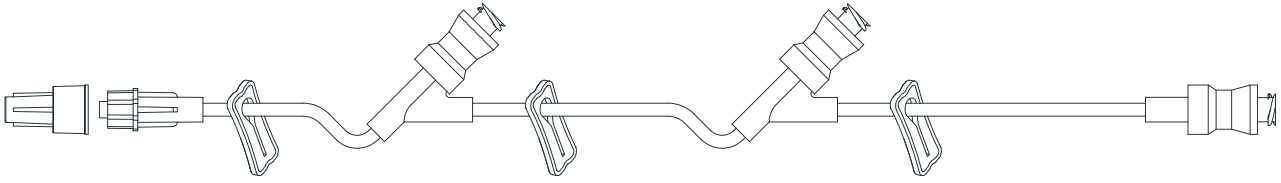

| Length (cm) | OD x ID (mm) | | | Priming volume (ml) | | | Reference Code | | |
|----------------|-----------------|-------|---------|------------------------|------|------|----------------|-------|-------|
| | 4.1x3 | 3.2x2 | 2.5x1.3 | 11.17 | 5.57 | 2.99 | EV3B1 | EV3B4 | EV3B7 |
| 150 | 4.1x3 | 3.2x2 | 2.5x1.3 | 11.17 | 5.57 | 2.99 | EV3B1 | EV3B4 | EV3B7 |
| 220 | 4.1x3 | 3.2x2 | 2.5x1.3 | 16.12 | 7.77 | 3.92 | EV3B2 | EV3B5 | EV3B8 |
| 280 | 4.1x3 | 3.2x2 | 2.5x1.3 | 20.34 | 9.65 | 4.71 | EV3B3 | EV3B6 | EV3B9 |

Each row along with the color represents OD x ID ,P.V and model.

Four way needle free extension tube, Model: EV4A

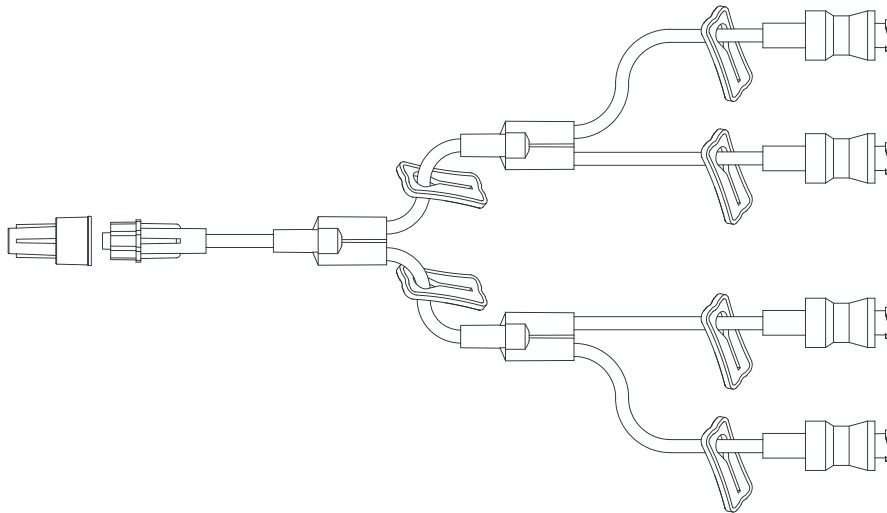

| Length (cm) | OD x ID (mm) | | | Priming volume (ml) | | | Reference Code | | |
|----------------|-----------------|-------|---------|------------------------|-----|-----|----------------|-------|-------|
| | 4.1x3 | 3.2x2 | 2.5x1.3 | 2.7 | 1.6 | 1.1 | EV4A1 | EV4A2 | EV4A3 |
| 20 | 4.1x3 | 3.2x2 | 2.5x1.3 | 2.7 | 1.6 | 1.1 | EV4A1 | EV4A2 | EV4A3 |

Each row along with the color represents OD x ID ,P.V and model.

Four way needle free extension tube, Model: EV4B

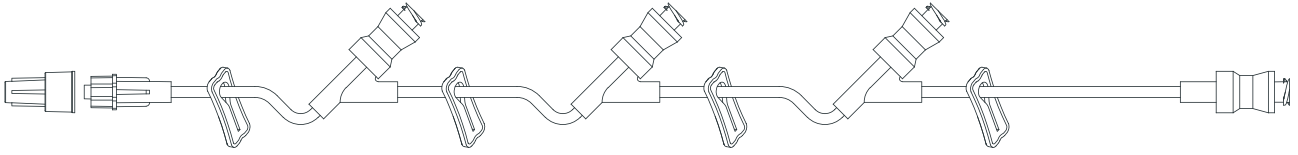

| Length (cm) | OD x ID (mm) | | | Priming volume (ml) | | | Reference Code | | |
|-------------|--------------|-------|---------|---------------------|------|------|----------------|-------|-------|
| 220 | 4.1x3 | 3.2x2 | 2.5x1.3 | 16.22 | 7.93 | 4.1 | EV4B1 | EV4B3 | EV4B5 |
| 280 | 4.1x3 | 3.2x2 | 2.5x1.3 | 20.44 | 9.8 | 4.89 | EV4B2 | EV4B4 | EV4B6 |

Each row along with the color represents OD x ID ,P.V and model.

Five way needle free extension tube, Model: EV5A

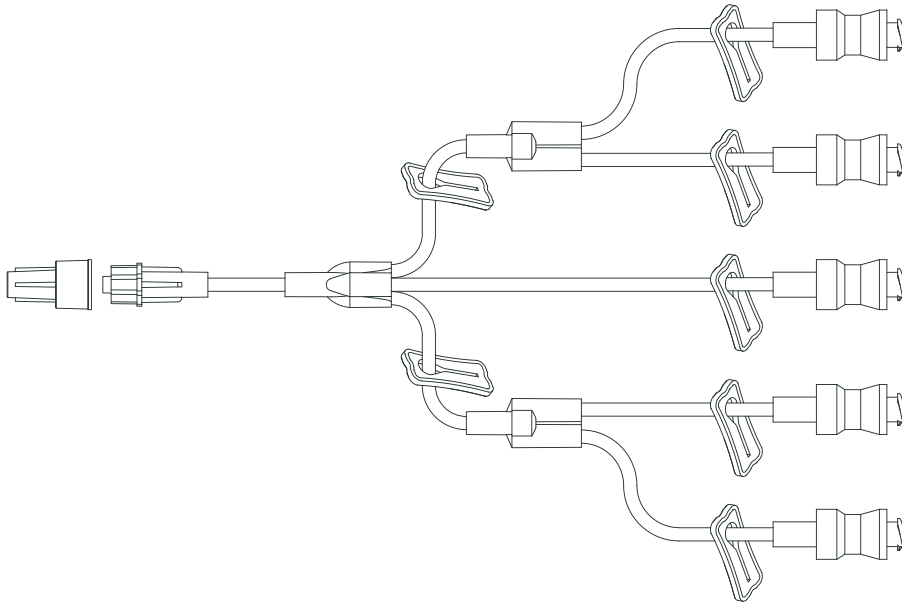

| Length (cm) | OD x ID (mm) | | | Priming volume (ml) | | | Reference Code | | |
|-------------|--------------|-------|---------|---------------------|------|------|----------------|-------|-------|
| 20 | 4.1x3 | 3.2x2 | 2.5x1.3 | 3.92 | 2.22 | 1.44 | EV5A1 | EV5A2 | EV5A3 |

Each row along with the color represents OD x ID ,P.V and model.

Five way needle free extension tube, Model: EV5B

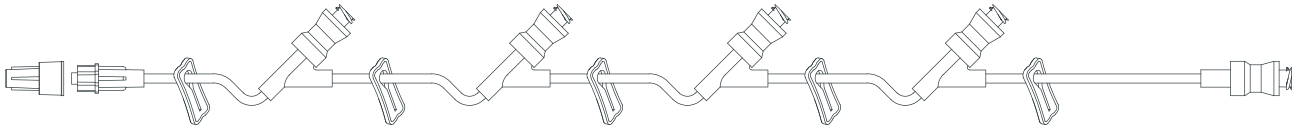

| Length (cm) | OD x ID (mm) | | | Priming volume (ml) | | | Reference Code | | |
|----------------|-----------------|-------|---------|------------------------|-------|------|----------------|-------|-------|
| | | | | | | | | | |
| 220 | 4.1x3 | 3.2x2 | 2.5x1.3 | 16.86 | 8.62 | 4.82 | EV5B1 | EV5B3 | EV5B6 |
| 280 | 4.1x3 | 3.2x2 | 2.5x1.3 | 21.11 | 10.51 | 5.62 | EV5B2 | EV5B4 | EV5B7 |

Each row along with the color represents OD x ID ,P.V and model.

LUER LOCK & NEEDLE FREE EXTENSION TUBE FAMILY

Two way luer lock & needle free extension tube, Model: EM2A

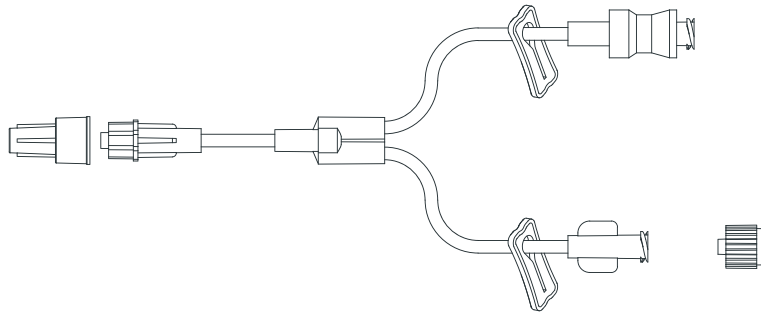

| Length (cm) | OD x ID (mm) | | | Priming volume (ml) | | | Reference Code | | |
|-------------|--------------|-------|---------|---------------------|------|------|----------------|-------|-------|
| 150 | 4.1x3 | 3.2x2 | 2.5x1.3 | 1.53 | 0.93 | 0.66 | EM2A1 | EM2A2 | EM2A3 |

Each row along with the color represents OD x ID ,P.V and model.

Two way luer lock & needle free extension tube, Model: EM2B

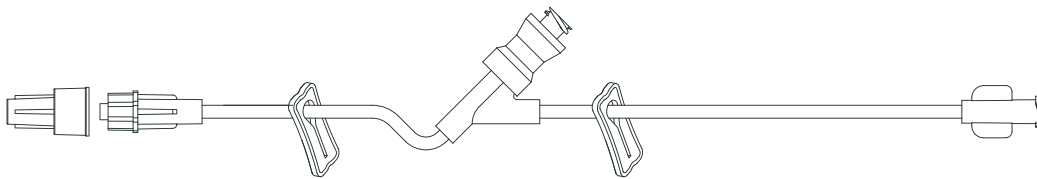

| Length (cm) | OD x ID (mm) | | | Priming volume (ml) | | | Reference Code | | |
|-------------|--------------|-------|---------|---------------------|------|------|----------------|-------|-------|
| 80 | 4.1x3 | 3.2x2 | 2.5x1.3 | 6.18 | 3.11 | 1.74 | EM2B1 | EM2B4 | EM2B7 |
| 150 | 4.1x3 | 3.2x2 | 2.5x1.3 | 11.03 | 5.31 | 2.67 | EM2B2 | EM2B5 | EM2B8 |
| 220 | 4.1x3 | 3.2x2 | 2.5x1.3 | 15.97 | 7.51 | 3.6 | EM2B3 | EM2B6 | EM2B9 |

Each row along with the color represents OD x ID ,P.V and model.

Three way luer lock & needle free extension tube, Model: EM3A

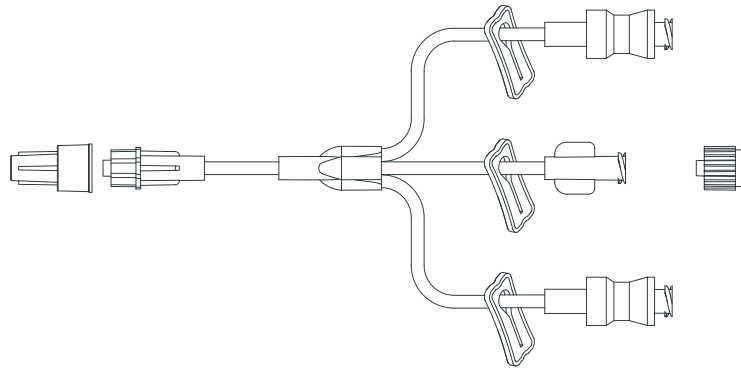

| Length (cm) | OD x ID (mm) | | | Priming volume (ml) | | | Reference Code | | |
|----------------|-----------------|-------|---------|------------------------|------|------|----------------|-------|-------|
| 15 | 4.1x3 | 3.2x2 | 2.5x1.3 | 2.06 | 1.24 | 0.87 | EM3A1 | EM3A2 | EM3A3 |

Each row along with the color represents OD x ID ,P.V and model.

Three way luer lock & needle free extension tube, Model: EM3B

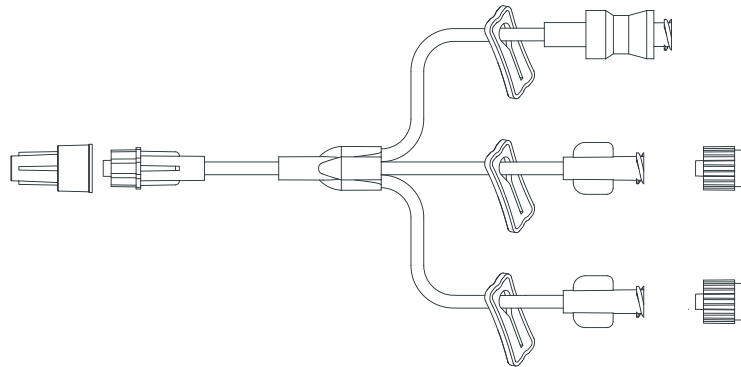

| Length (cm) | OD x ID (mm) | | | Priming volume (ml) | | | Reference Code | | |
|----------------|-----------------|-------|---------|------------------------|------|------|----------------|-------|-------|
| 16 | 4.1x3 | 3.2x2 | 2.5x1.3 | 2.53 | 1.52 | 1.05 | EM3B1 | EM3B2 | EM3B3 |

Each row along with the color represents OD x ID ,P.V and model.

Three way luer lock & needle free extension tube, Model: EM3C

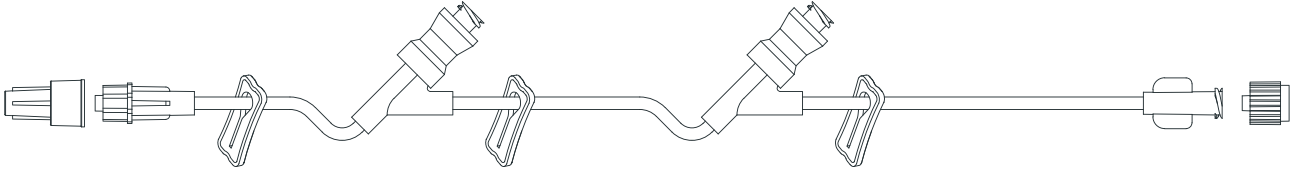

| Length (cm) | OD x ID (mm) | | | Priming volume (ml) | | | Reference Code | | |
|-------------|--------------|-------|---------|---------------------|------|------|----------------|-------|-------|
| 80 | 4.1x3 | 3.2x2 | 2.5x1.3 | 6.62 | 3.61 | 2.22 | EM3C1 | EM3C4 | EM3C7 |
| 150 | 4.1x3 | 3.2x2 | 2.5x1.3 | 11.36 | 5.72 | 3.11 | EM3C2 | EM3C5 | EM3C8 |
| 220 | 4.1x3 | 3.2x2 | 2.5x1.3 | 16.71 | 8.1 | 4.12 | EM3C3 | EM3C6 | EM3C9 |

Each row along with the color represents OD x ID ,P.V and model.

Four way luer lock & needle free extension tube, Model: EM4A

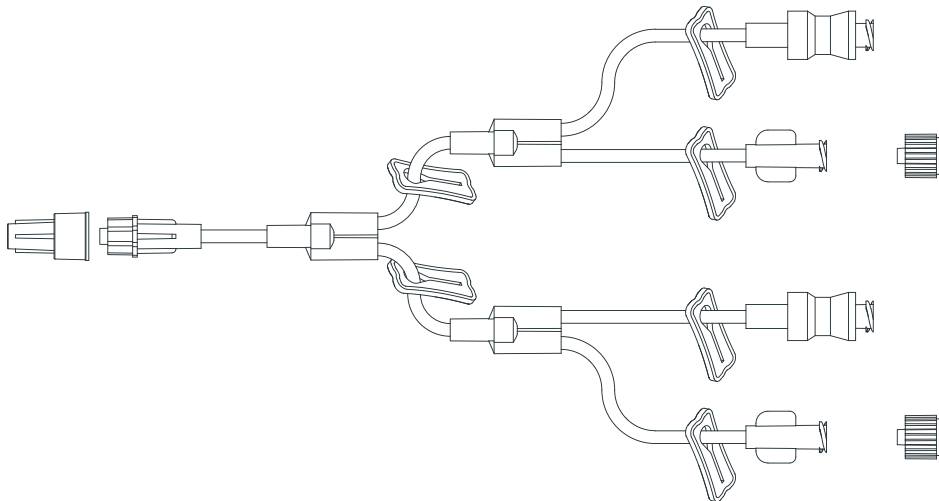

| Length (cm) | OD x ID (mm) | | | Priming volume (ml) | | | Reference Code | | |
|-------------|--------------|-------|---------|---------------------|------|------|----------------|-------|-------|
| 20 | 4.1x3 | 3.2x2 | 2.5x1.3 | 3.29 | 1.96 | 1.33 | EM4A1 | EM4A2 | EM4A3 |

Each row along with the color represents OD x ID ,P.V and model.

Four way luer lock & needle free extension tube, Model: EM4B

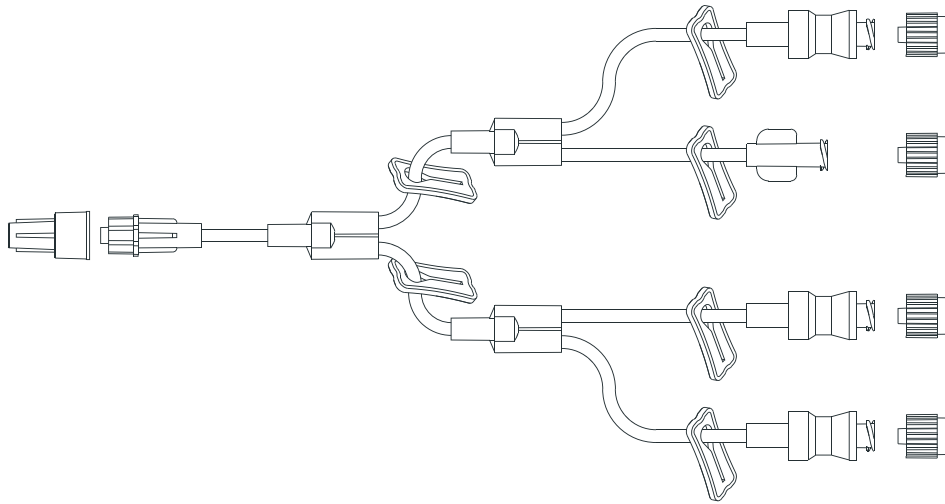

| Length (cm) | OD x ID (mm) | | | Priming volume (ml) | | | Reference Code | | |
|----------------|-----------------|-------|---------|------------------------|------|------|----------------|-------|-------|
| 20 | 4.1x3 | 3.2x2 | 2.5x1.3 | 3.21 | 1.89 | 1.28 | EM4B1 | EM4B2 | EM4B3 |

Each row along with the color represents OD x ID ,P.V and model.

Four way luer lock & needle free extension tube, Model: EM4C

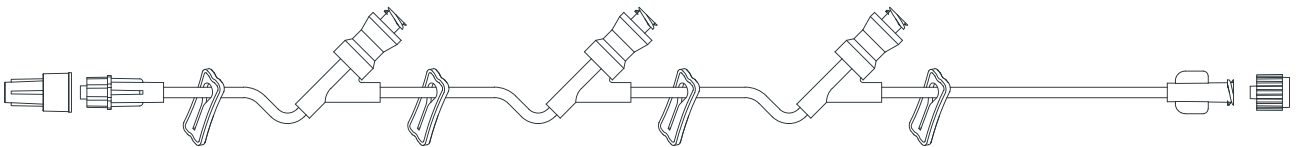

| Length (cm) | OD x ID (mm) | | | Priming volume (ml) | | | Reference Code | | |
|----------------|-----------------|-------|---------|------------------------|-------|------|----------------|-------|-------|
| 220 | 4.1x3 | 3.2x2 | 2.5x1.3 | 17.06 | 8.51 | 4.56 | EM4C1 | EM4C3 | EM4C5 |
| 280 | 4.1x3 | 3.2x2 | 2.5x1.3 | 20.95 | 10.24 | 5.29 | EM4C2 | EM4C4 | EM4C6 |

Each row along with the color represents OD x ID ,P.V and model.

Five way luer lock & needle free extension tube, Model: EM5A

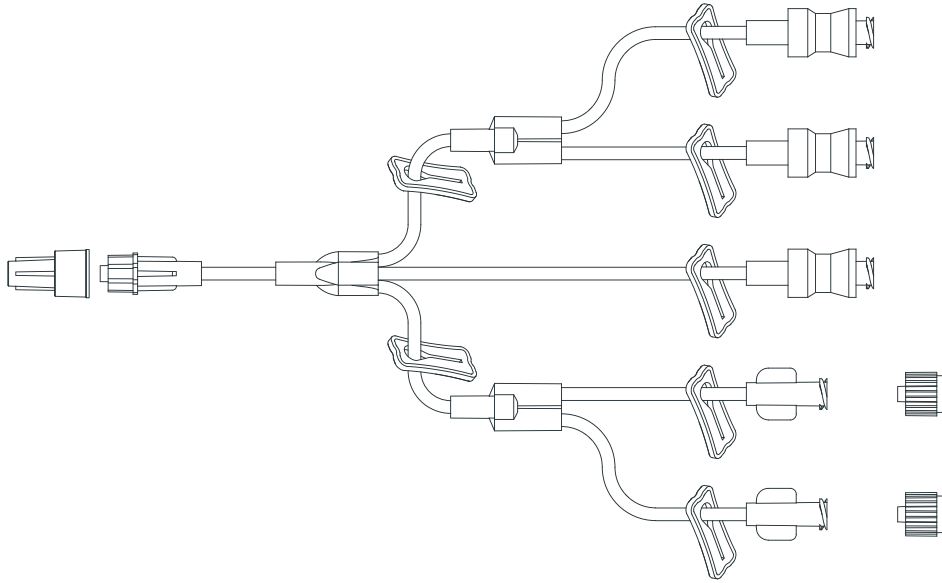

| Length (cm) | OD x ID (mm) | | | Priming volume (ml) | | | Reference Code | | |
|----------------|-----------------|-------|---------|------------------------|------|------|----------------|-------|-------|
| 20 | 4.1x3 | 3.2x2 | 2.5x1.3 | 4.26 | 2.50 | 1.68 | EM5A1 | EM5A2 | EM5A3 |

Each row along with the color represents OD x ID ,P.V and model.

Five way luer lock & needle free extension tube, Model: EM5B

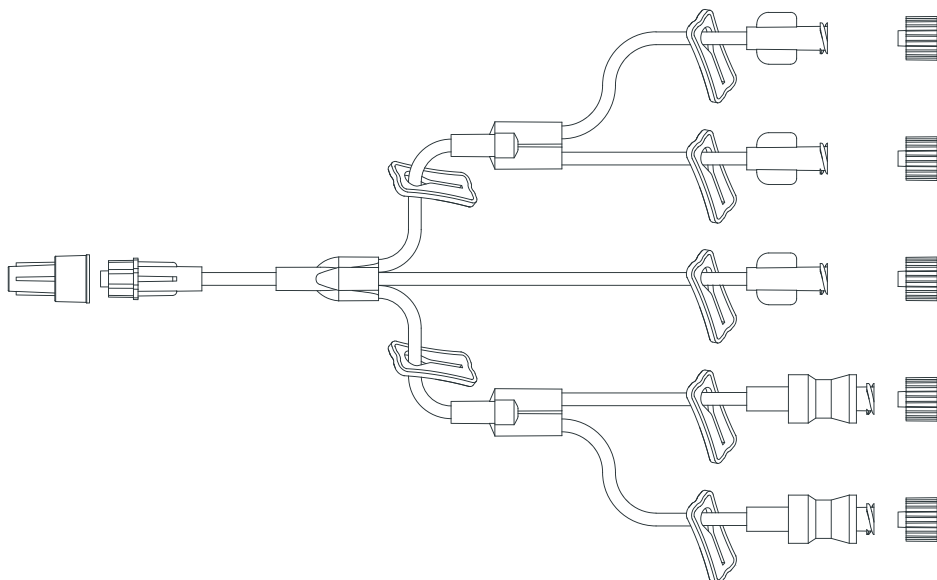

| Length (cm) | OD x ID (mm) | | | Priming volume (ml) | | | Reference Code | | |
|----------------|-----------------|-------|---------|------------------------|------|-----|----------------|-------|-------|
| 20 | 4.1x3 | 3.2x2 | 2.5x1.3 | 4.44 | 2.64 | 1.8 | EM5B1 | EM5B2 | EM5B3 |

Each row along with the color represents OD x ID ,P.V and model.

Five way luer lock & needle free extension tube, Model: EM5C

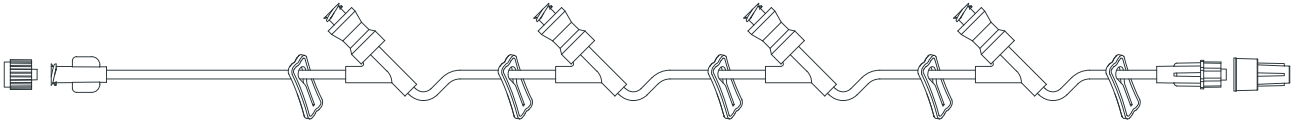

| Length (cm) | OD x ID (mm) | | | Priming volume (ml) | | | Reference Code | | |
|----------------|-----------------|-------|---------|------------------------|-------|------|----------------|-------|-------|
| | 4.1x3 | 3.2x2 | 2.5x1.3 | 17 | 8.75 | 4.93 | EM5C1 | EM5C3 | EM5C5 |
| 220 | 4.1x3 | 3.2x2 | 2.5x1.3 | 17 | 8.75 | 4.93 | EM5C1 | EM5C3 | EM5C5 |
| 280 | 4.1x3 | 3.2x2 | 2.5x1.3 | 21.24 | 10.63 | 5.73 | EM5C2 | EM5C4 | EM5C6 |

Each row along with the color represents OD x ID ,P.V and model.



www.asiagoldman.com
info@asiagoldman.com

No17, Nejad Kay St
Mirzay-e-Shirazi Ave
T e h r a n - I r a n
Tel:+98 21 88836643
fax:+98 21 86073395

تهران خیابان میرزای شیرازی
خیابان نژادکی پلاک ۱۷
تلفن : ۴۳ ۲۲ ۸۳ ۸۸
فکس : ۹۵ ۳۳ ۰۷ ۸۶

Distributed by :

